

**This electronic collection of documents is provided  
for the convenience of the user  
and is Not a Certified Document –**

**The documents contained herein were originally issued  
and sealed by the individuals whose names and license  
numbers appear on each page, on the dates appearing  
with their signature on that page.**

**This file or an individual page  
shall not be considered a certified document.**



6/23/16

0 2.5 5	PROJ. REFERENCE NO. 17BP.14.R.162	SHEET NO. X-1
---------	--------------------------------------	------------------

75 70 65 60 55 50 45 40 35 30 25 20 15 10 5 0 5 10 15 20 25 30 35 40 45 50 55 60 65 70 75

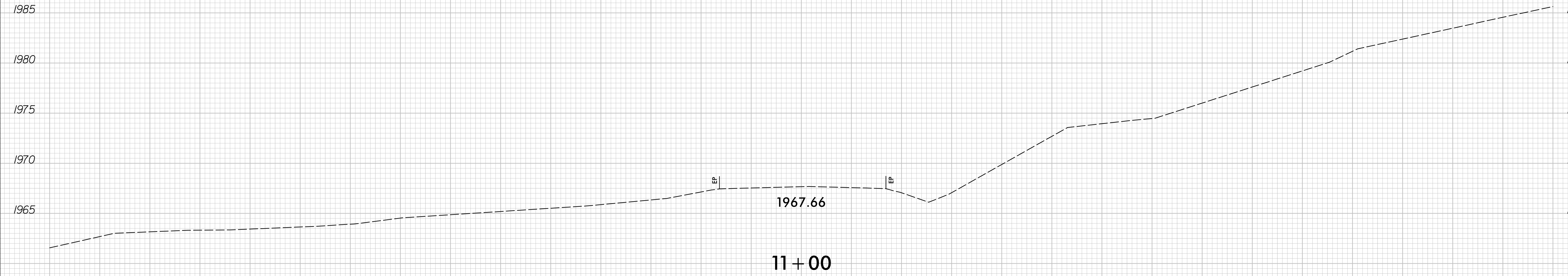
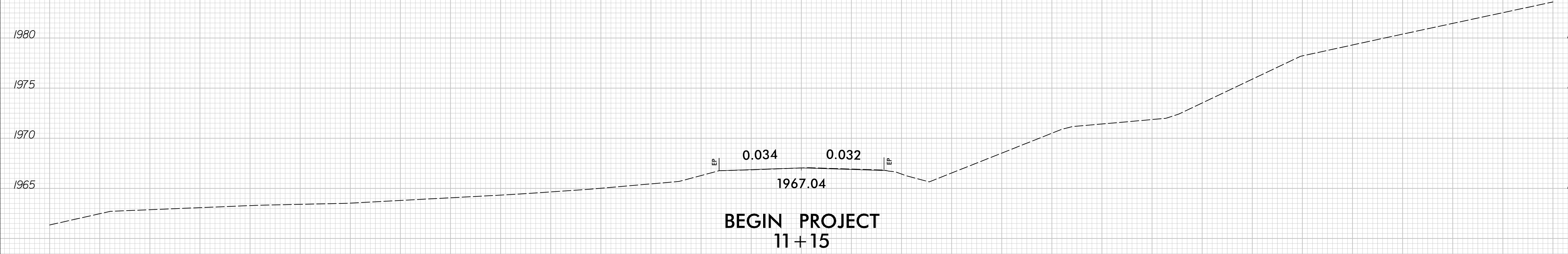
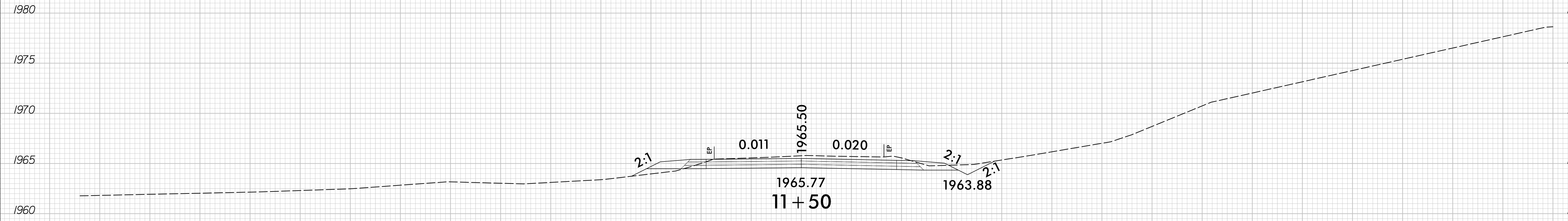

75 70 65 60 55 50 45 40 35 30 25 20 15 10 5 0 5 10 15 20 25 30 35 40 45 50 55 60 65 70 75

1/25/2019 11:00:00 AM \\sac\17BP14R162\_rdu\p1.L.dgn

6/23/16

0 2.5 5	PROJ. REFERENCE NO. 17BP.14.R.162	SHEET NO. X-2
---------	--------------------------------------	------------------

75 70 65 60 55 50 45 40 35 30 25 20 15 10 5 0 5 10 15 20 25 30 35 40 45 50 55 60 65 70 75

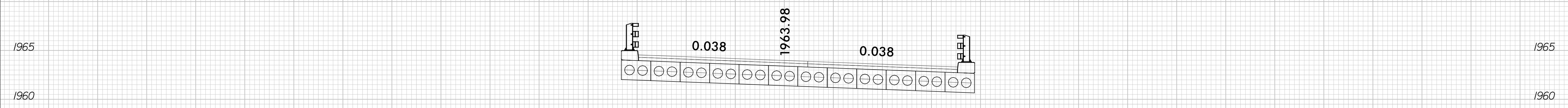

1965  
1960  
1955  
1950

1952.71  
**13 + 00**

1965  
1960  
1955

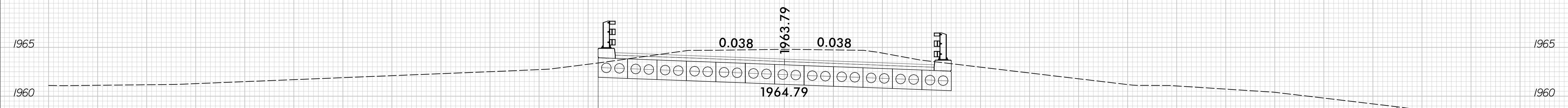

1965  
1960  
1955

1963.79  
1964.79  
1957.00  
**12 + 58.74  
BEGIN BRIDGE**

1.5:1

1965  
1960  
1955

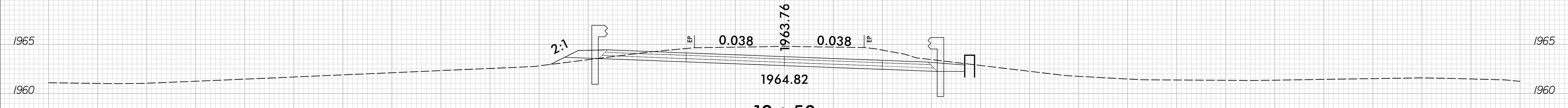

1965  
1960  
1955

1963.76  
1964.82  
**12 + 50**

2:1

1965  
1960  
1955

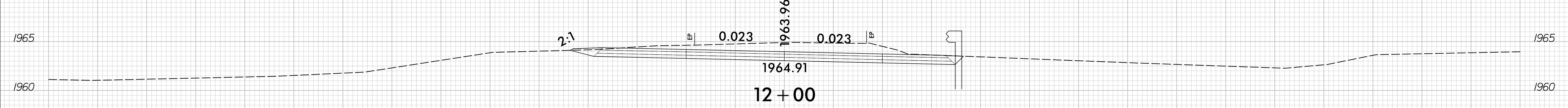

1965  
1960

1963.96  
1964.91  
**12 + 00**

2:1

1965  
1960

75 70 65 60 55 50 45 40 35 30 25 20 15 10 5 0 5 10 15 20 25 30 35 40 45 50 55 60 65 70 75

1/25/2019 1:14:00 PM \\sdc\17BP14R162\_rdu\_xpl.L.dgn

6/23/16

0 2.5 5	PROJ. REFERENCE NO. 17BP.14.R.162	SHEET NO. X-3
---------	--------------------------------------	------------------

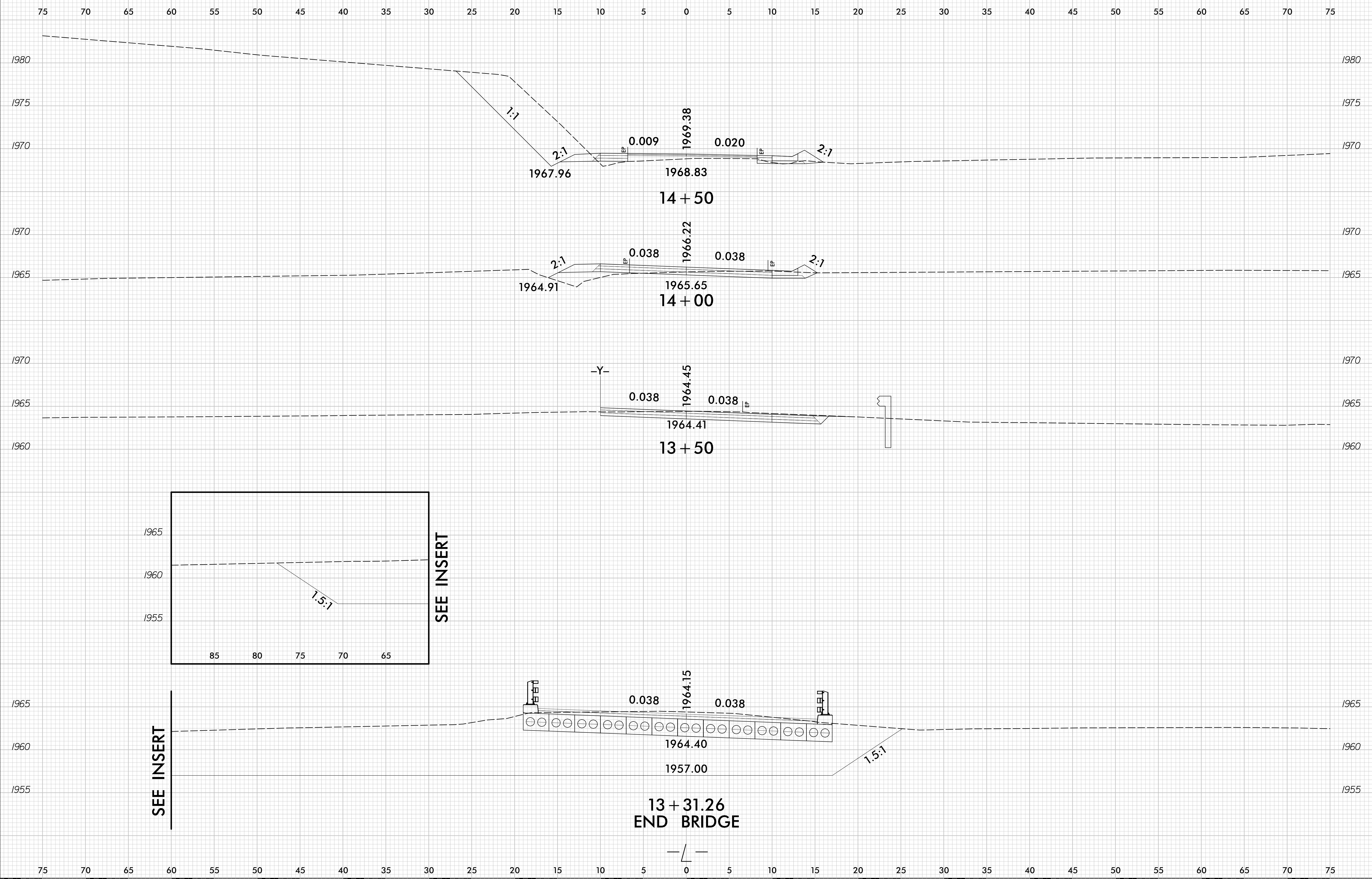

1/25/2019  
T:\p\o\dw\ay\ssc\17BP14R162\_rdy\_xpl.dgn  
T:\p\o\dw\ay\ssc\17BP14R162\_rdy\_xpl.dgn

6/23/16

0 2.5 5	PROJ. REFERENCE NO. 17BP.14.R.162	SHEET NO. X-4
---------	--------------------------------------	------------------

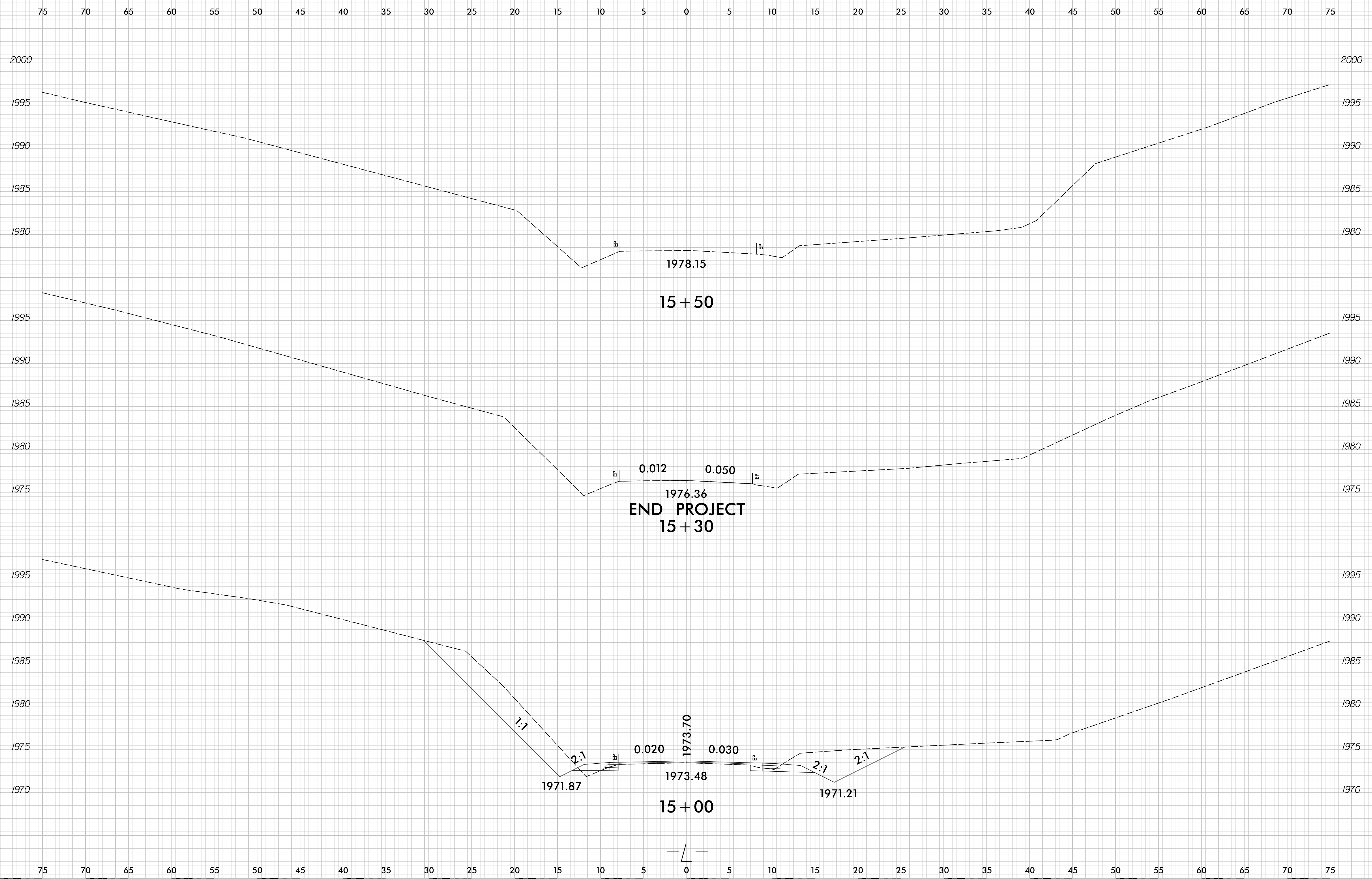

1/25/2019  
T:\p\ced\j\17BP14R162\_rdu\_xpl.dgn  
T:\p\ced\j\17BP14R162\_rdu\_xpl.dgn

6/23/16

0 2.5 5	PROJ. REFERENCE NO. 17BP.14.R.162	SHEET NO. X-5
---------	--------------------------------------	------------------

75 70 65 60 55 50 45 40 35 30 25 20 15 10 5 0 5 10 15 20 25 30 35 40 45 50 55 60 65 70 75

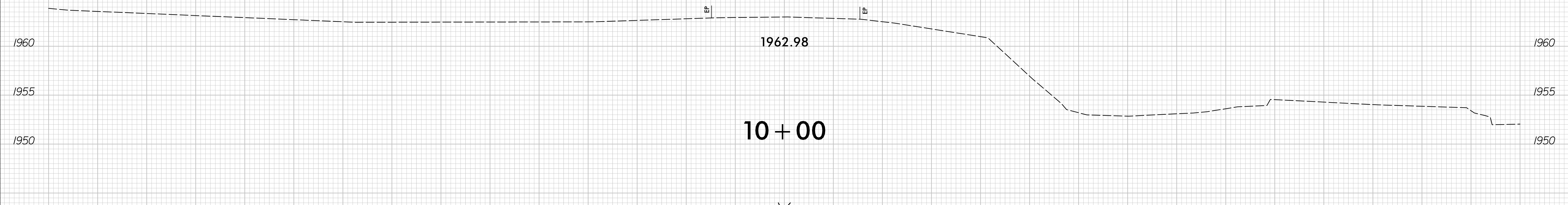
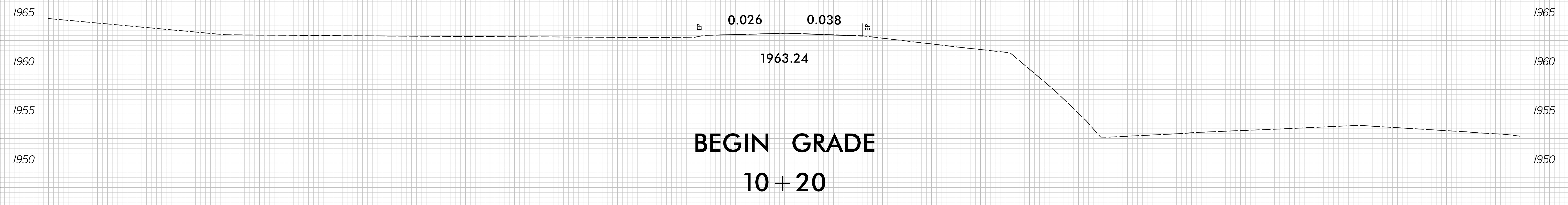
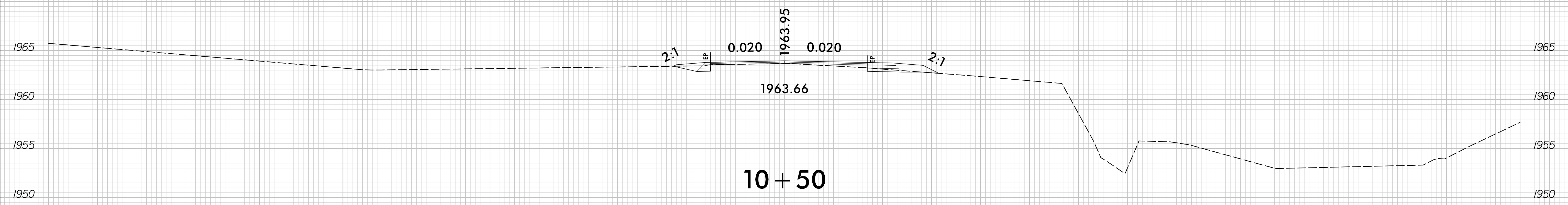

75 70 65 60 55 50 45 40 35 30 25 20 15 10 5 0 5 10 15 20 25 30 35 40 45 50 55 60 65 70 75

I:\25\2019  
17BP14R162\_rdy\_xp1.Y.dgn  
17BP14R162

6/23/16

0 2.5 5	PROJ. REFERENCE NO. 17BP.14.R.162	SHEET NO. X-6
---------	--------------------------------------	------------------

75 70 65 60 55 50 45 40 35 30 25 20 15 10 5 0 5 10 15 20 25 30 35 40 45 50 55 60 65 70 75

1990 1985 1980 1975 1970 1965 1960 1955 1950

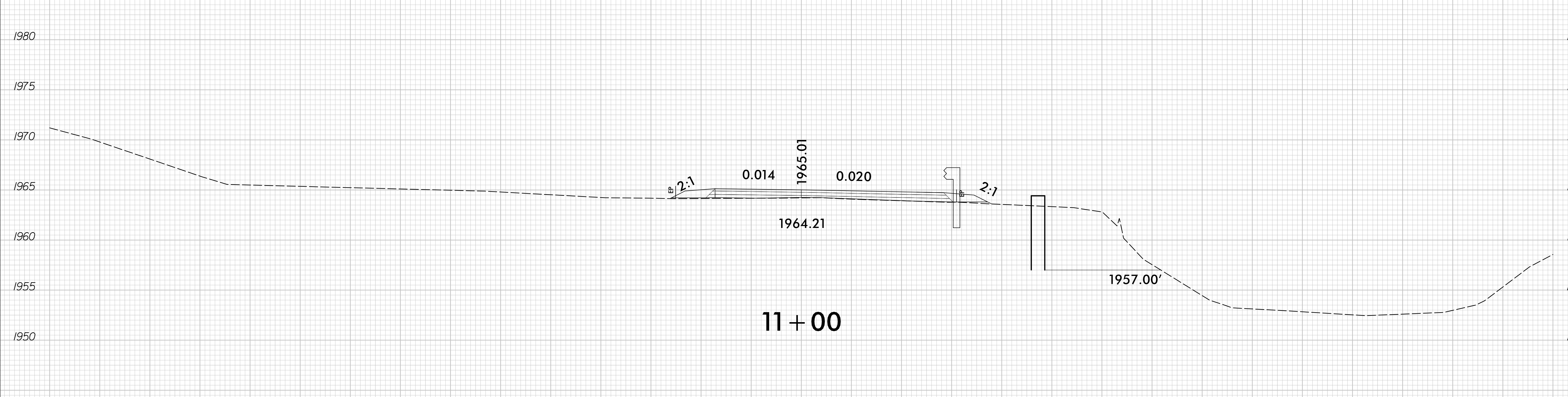
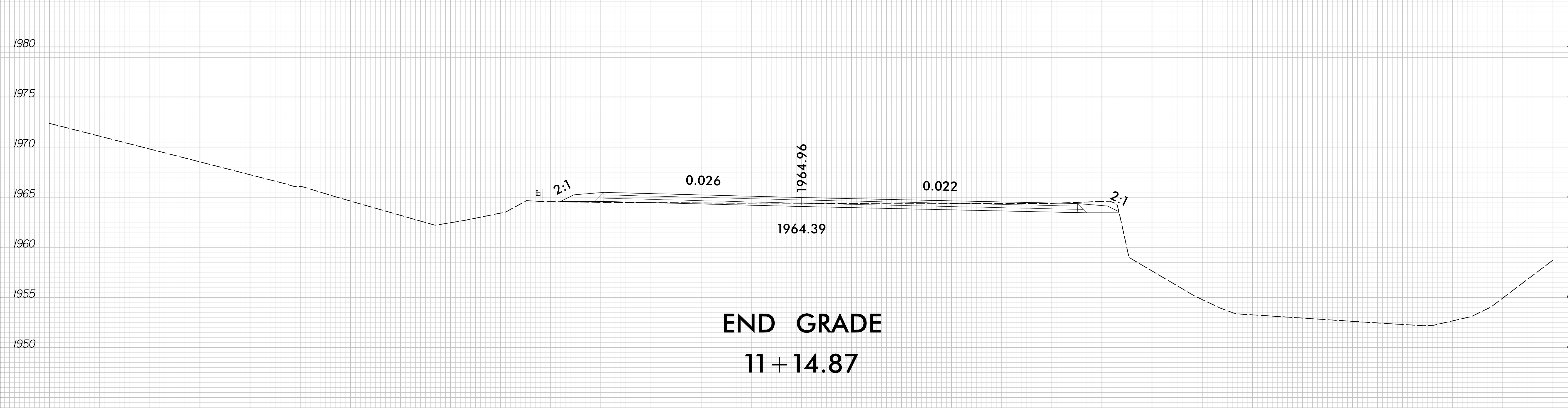

75 70 65 60 55 50 45 40 35 30 25 20 15 10 5 0 5 10 15 20 25 30 35 40 45 50 55 60 65 70 75

1/25/2019  
R:\Roadway\Xsc\17BP14R162\_rdy\_xpl\_Y.dgn  
T:\dsc\W1